



Secondary Security Index

- **Introduction** SS2
- Window Security**
- **Window Types** SS3
- **Features and Functions** SS3
- **Photo Gallery** SS4
- **Range Table** SS5
- **Locks for Hinged Windows** SS6 - 9
- **Locks for Sliding Windows** SS10 - 11
- Door Security**
- **Door Types** SS11
- **Features and Functions** SS11
- **Photo Gallery** SS12
- **Range Table** SS13
- Security for Hinged Doors**
- **Door Bolts** SS14
- **Door Viewers** SS15
- **Door Chains** SS16
- **Hinge Bolts** SS16
- Security for Sliding Doors** SS17 - 18
- **Notes** SS19

Note: We have made every effort to ensure that at the time of going to print all information shown in this catalogue is correct. However, in our efforts to continually improve our products and offer only the highest levels of security and quality we reserve the right to make alterations to the product specifications shown in this catalogue. All dimensions provided within this catalogue are approximate and for guidance only.

Introduction

Chubb have a very comprehensive range of high quality secondary security products to improve the security on doors and windows.

Locks are available to suit wooden, metal and plastic windows that help to secure hinged or sliding window types.

Additional security fittings for all types of doors are available in the Chubb range. Bolts, viewers and chains are designed to fit standard hinged doors and locks are available to secure aluminium and wooden sliding patio doors.



Chubb is accredited with and meets the requirements of BSEN9001

Keying Groups

Throughout the catalogue you will see a column headed **Key Control**

The information shown under this heading can help you identify which products can be Keyed Alike or Masterkeyed.

Many products in the Chubb Secondary Security Range have the same keying mechanism and so can be conveniently operated from a single key. Locks offering this option will either have a universal key operation OR a group code reference which matches it to other products in the same group - eg. the 8K13 is a unique key in key control group F, so it could be keyed alike to any other product in group F, like the 8K114.

For the complete list of Chubb product keying groups, see the chart in the introduction section.

How to Specify

Chubb have developed a series of icons to enable the process of product specification to be simplified.

From today you can specifically detail your requirements for a product, therefore ensuring that it includes particular security features. These will give confidence when specifying and ensure that the right products are used on the right application.

Example: If you require a door lock that is Tamper Resistant look for the screwdriver icon (7) in the range table.

Chubb, Simplifying the Specification Process.

Security Features

- 1 **Protected Section**
Products are available as an option on a patented key section.
- 2 **Drill Resistant**
Hardened protection against drill attack.
- 3 **Saw Resistant**
Hardened protection against saw attack.
- 4 **Force Resistant**
Built in strength against force attack.
- 5 **Pick Resistant**
Built in protection to resist picking.
- 6 **Torque Resistant**
Built in strength against torque attack.
- 7 **Tamper Resistant**
Built in protection against Tampering.
- 8 **Corrosion Resistant**
Products conform to appropriate anti-corrosion requirements.
- 9 **Fire Resistant**
Products conform to appropriate fire test requirements.
- 10 **Escape**
Products for use on an escape door.
- 11 **Key Control**
The products can be included in a key control system.
- 12 **Guarantee**
Products are guaranteed for a period of time.

Keys

Products are available with or without keys.

See the price list for details.



Trade and Multi Pack Options

Various pack sizes and formats are available, see the price list for details.



Window Types

Hinged Casement Windows

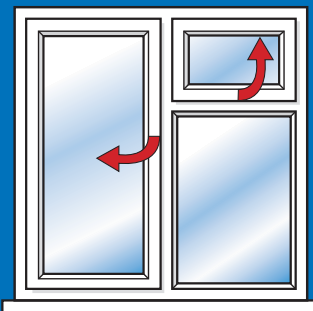

Materials

- T Timber
- M Metal
- P PVCu

Narrow Frame

Many Chubb locks have a body of 20mm or less and are therefore suitable for a narrow frame

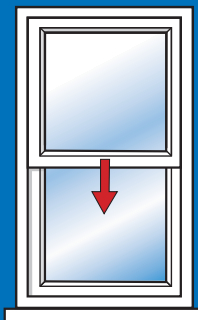

Sliding Sash Windows

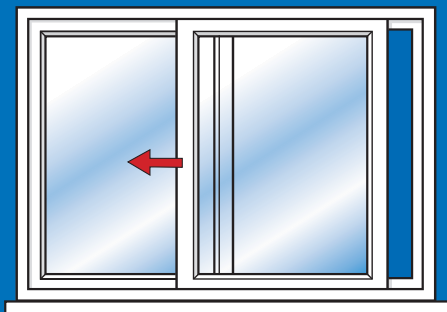

Features and Functions

Ventilation Position

Some locks allow the window to be locked both in the closed and in a slightly open position allowing ventilation.



Wedge

For tapered frames a wedge is supplied to square up the lock to the window section.



Tamper Resistant
Concealed fixings.



Key Control
It is possible to make locks in the same keying group work from the same key.



Guarantee
Guarantee period applicable when used with original Chubb Keys and maintenance instructions followed.

Fitting Aids

Many products are supplied with **Ease of Fitting** in mind and are supplied with fitting aids as standard.

Drill Bit

To help make sure your lock fixings are secure the correct size bit is pre-packed.



Universal or Unique Key

Universal key means there is one standard key that works the lock.

Unique Key means that variations of the key shape provide a different number of keys to the lock.



Finishes: Brass White Brown

Additional Security: On windows larger than 0.5 metre sq. it is recommended that 2 locks are fitted to help against a force attack



Locks for Hinged Windows



Chubb 8001 Page SS6



Chubb 8K100 Page SS6



Chubb 8K101 Page SS6



Chubb 8K102 Page SS7



Chubb 8K109 Page SS7

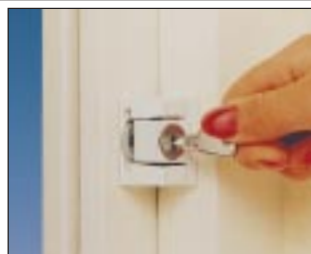

Chubb 8K113 Page SS7

Locks for Hinged Windows



Chubb 8K118 Page SS8



Chubb 8K120 Page SS8



Chubb 8012 Page SS8



Chubb 8K106 Page SS9



Chubb 8K123 Page SS9

Locks for Sliding Sash Windows



Chubb 8013 Page SS9



Chubb 8K104 Page SS9



Chubb 8K108 Page SS10



Chubb 8K114 Page SS10



Chubb WS1 Page SS10

Chubb®

Window Security



Features/Functions

Window Specification

Case Finishes

Chubb Locks for Pivoted Windows

Model	Tamper Resistant	Key Control	Guarantee	Universal/Unique Key	Key	Locking Method	Locks Existing Fastener	Ventilation Position	Fitting Aids Supplied	Window Material	Suited to Narrow Frame	Brass	White	Brown
8001 Window Bolt	●	E	10	Universal	●					T		●	●	
8K100 Window Lock	●	C	10	Unique	●	●			DB	TM	●		●	
8K101 Window Lock	●	B	10	Universal	●					T	●	●	●	●
8K102 Window Lock	●		10	Universal		●			WED	T	●	●	●	●
8K109 Window Lock	●		10	Universal	●				WED	T	●		●	
8K113 Window Lock	●	F	10	Unique	●				WED	T	●		●	
8K118 Window Lock		B	10	Universal	●					T	●	●	●	
8K120 Window Lock	●		10	Universal			●		WED	T	●	●	●	●
8012 Window Lock	●	C	10	Unique		●	●			M	●	●		
8K106 Window Lock	●	B	10	Universal	●				DB	M	●		●	
8K123 Window Lock	●	B	10	Universal	●				DB	P	●		●	

Chubb Locks for Sliding Sash Windows

8013 Window Bolt		D	10	Universal	●					T	●	●		
8K104 Window Bolt	●	D	10	Universal	●				DB	T	●	●		
8K108 Window Lock	●		10	Universal	●					T			●	
8K114 Window Lock	●	F	10	Unique	●			●		T			●	
WS1 Ventilation Lock			10	Universal	●			●		T		●		

Key: Fixings Supplied: WED = Wedge, DB = Drill Bit.



Locks for Hinged Windows

Chubb 8001 Window Bolt

- Mortise bolt that fits into the window section and is shot into the frame.

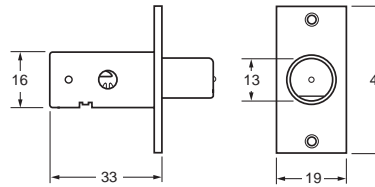
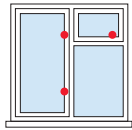

Chubb 8K100 Window Lock

- Lock for surface fixing onto the window section. Bolt is thrown into the fixed frame by turning the catch, the bolt is then unlocked with the key.

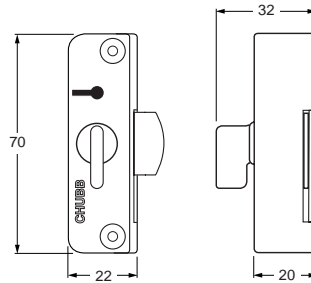
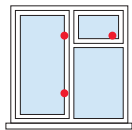

Chubb 8K101 Window Lock

- Lock is surface fixed onto the window section and is locked around the frame fixed staple by use of the key.
- A clenching action helps to pull the window to the frame.

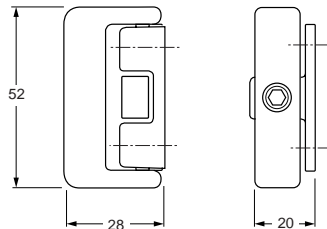
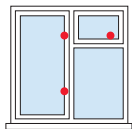

		8001	8K100	8K101
Security Features				
	Tampers Resistant	•	•	•
	Key Control	E	C	B
	Guarantee	10	10	10
Features/Functions				
Universal/Unique Key		Universal	Unique	Universal
Locking Method	Key	•	•	•
	Manual		•	
	Automatic			
Locks Existing Fastener				
Ventilation Position				
Fitting Aids Supplied			DB	
Window Specification				
Window Material		T	TM	T
Suited to Narrow Frame			•	•
Case Finishes				
Brass		•		•
White		•	•	•
Brown				•



Window Security

Locks for Hinged Windows

Chubb 8K102 Window Lock

- Lock for surface fixing to the fixed frame which is locked onto the lock plate on the window section by pushing the lock barrel.
- Easy to use 'Push to lock' system.
- Released by key.

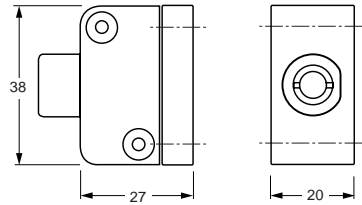
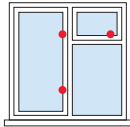

Chubb 8K109 Window Lock

- Lock is surface fixed onto the window section, locking into the fixed frame by use of the key.

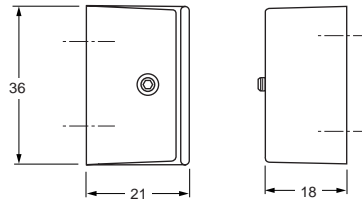
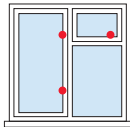

Chubb 8K113 Window Lock

- Surface fixed lock which locks on an oval locking plate with the turn of the key. Lock is mounted on the fixed frame.

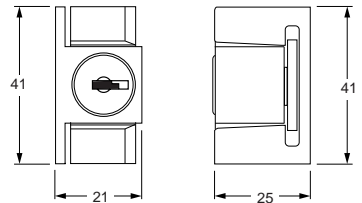
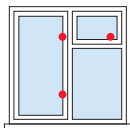

		8K102	8K109	8K113
Security Features				
	Tamper Resistant	•	•	•
	Key Control			F
	Guarantee	10	10	10
Features/Functions				
Universal/Unique Key		Universal	Universal	Unique
Locking Method	Key		•	•
	Manual	•		
	Automatic			
Locks Existing Fastener				
Ventilation Position				
Fitting Aids Supplied		WED	WED	WED
Window Specification				
Window Material		T	T	T
Suited to Narrow Frame		•	•	•
Case Finishes				
Brass		•		
White		•	•	•
Brown		•		

Locks for Hinged Windows

Chubb 8K118 Window Lock

- Lock is surface fixed onto the window section and is locked into the striking plate on the fixed frame by use of the key.
- Simple and cost effective.

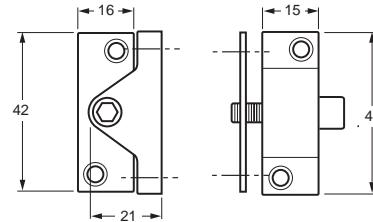
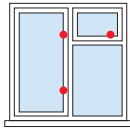

Chubb 8K120 Window Lock

- Lock is surface fitted to the fixed frame and is automatically locked on closing the window. The window and locking plate are released by use of the key.

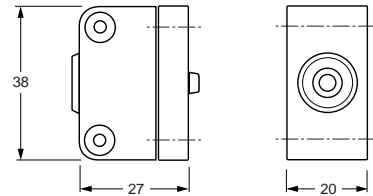
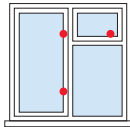

Chubb 8012 Window Lock

- A surface fitted lock for securing a window handle cockspur fastener. The lock slides into position to restrict the handle movement and is released by use of the key.

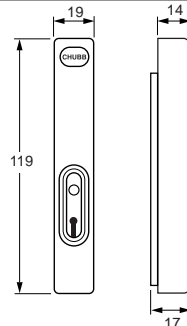
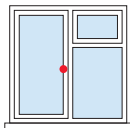

		8K118	8K120	8012
Security Features				
	Tamper Resistant		•	•
	Key Control	B		C
	Guarantee	10	10	10
Features/Functions				
Universal/Unique Key		Universal	Universal	Unique
Locking Method	Key	•		
	Manual			•
	Automatic		•	
Locks Existing Fastener				•
Ventilation Position				
Fitting Aids Supplied			WED	
Window Specification				
Window Material		T	T	M
Suited to Narrow Frame		•	•	•
Case Finishes				
Brass		•	•	•
White		•	•	
Brown			•	

Locks for Hinged Windows

Chubb 8K106 Window Lock

- Lock is surface fixed onto the window section and is locked around the frame fixed staple by use of the key.
- For use on metal windows only.

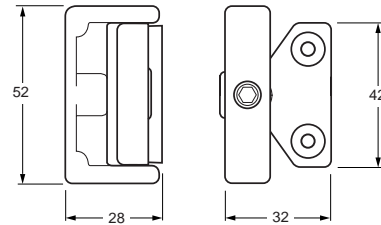
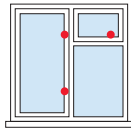

Chubb 8K123 Window Lock

- Lock for surface fixing onto the window section which is locked around the frame fixed staple by use of the key.
- For use on PVCu windows only.

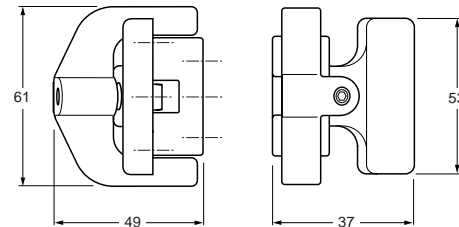
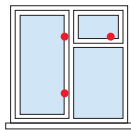

Locks for Sliding Sash Windows

Chubb 8013 Window Bolt

- The threaded lock barrel is fixed into the inner frame and the window is secured by locking the inner bolt into the barrel and frame using the key.
- Can also be used in hinged windows.
- Screw in fitting barrel.



Chubb 8K104 Window Bolt

- The tap in fitting lock barrel is fixed into the inner frame and the window is secured by locking the inner bolt into the barrel and frame using the key.
- Can also be used in hinged windows.
- Tap in fitting barrel and keep.



	8K106	8K123	8013	8K104
Security Features				
Tamper Resistant	•	•		•
Key Control	B	B	D	D
Guarantee	10	10	10	10
Features/Functions				
Universal/Unique Key	Universal	Universal	Universal	Universal
Locking Method	Key	•	•	•
	Manual			
	Automatic			
Locks Existing Fastener				
Ventilation Position				
Fitting Aids Supplied	DB	DB		DB
Window Specification				
Window Material	M	P	T	T
Suited to Narrow Frame	•	•	•	•
Case Finishes				
Brass			•	•
White	•	•		
Brown				



Window Security

Locks for Sliding Sash Windows

Chubb 8K108 Window Lock

- Lock is surface fixed across the window sections and the case is locked to the lock plate using the key.

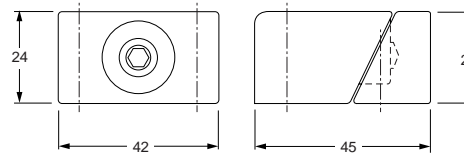
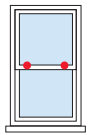

Chubb 8K114 Window Lock

- Lock is surface fitted and secured by a locking bar which locks both window sections in place. The bar is secured and released by the key.
- Handy storage for locking bar when not in use.
- One way security screws.

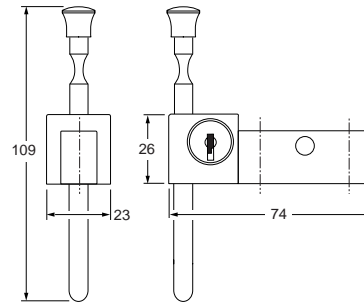
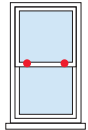

Chubb WS1 Ventilation Lock

- A key operated bolt is morticed into the outer window frame which when locked out will prevent the inner window from opening.

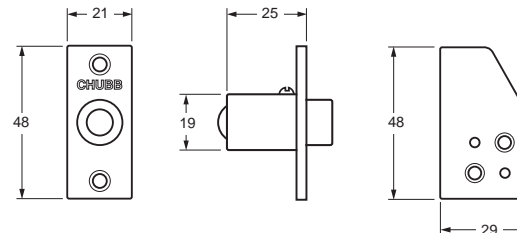
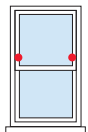

		8K108	8K114	WS1
Security Features				
	Tamper Resistant	•	•	
	Key Control		F	
	Guarantee	10	10	10
Features/Functions				
Universal/Unique Key		Universal	Unique	Universal
Locking Method	Key	•	•	•
	Manual			
	Automatic			
Locks Existing Fastener				
Ventilation Position			•	•
Fitting Aids Supplied				
Window Specification				
Window Material		T	T	T
Suited to Narrow Frame				
Case Finishes				
Brass				•
White		•	•	
Brown				



What Type of Door ?

- A comprehensive range of security devices for both exterior and interior glass panelled or solid doors.

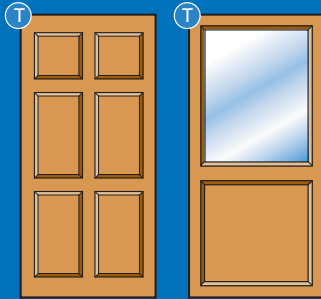

Door Types

- T Timber
- M Metal
- P PVCu

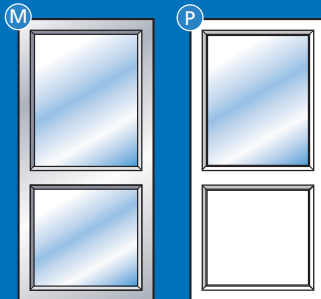

- Sliding Patio Doors

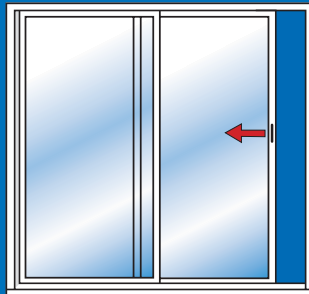

Features and Functions

Angle of Vision

All door viewers have a viewing area in which to see movement. This is measured in degrees.

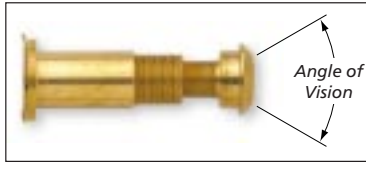

Unlocked Indicator

Some products have a method of showing whether the lock is in the locked or unlocked position.



Fitting Aids

Many products are supplied with **Ease of Fitting** in mind and are supplied with fitting aids as standard

Drill Bit

To help make sure your lock fixings are secure the correct size bit is pre-packed

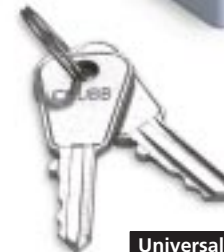

Universal or Unique Key

Universal key means there is one standard key that works the lock. **Unique Key** means that variations of the key shape provide a different number of keys to the lock.

Drill Resistant
Metal sleeve for drill protection.

Saw Resistant
Hardened pin in bolt for sawing protection.

Tamper Resistant
Concealed fixings.

Key Control
It is possible to make locks in the same keying group, work from the same key.

Guarantee
Guarantee period applicable when used with original Chubb keys and maintenance instructions followed.

Finishes: Brass Satin Chrome White Brown

Additional Security: Where mortice bolts and/or hinge bolts are used, 2 per door are recommended to help against a force attack.



Security for Hinged Doors



Chubb 8002 Page SS14



Chubb 8004 Page SS14



Chubb 8006 Page SS14



Chubb 8K117 Page SS15



Chubb 8V001 Page SS15



Chubb WS8 Page SS15

Security for Hinged Doors



Chubb WS9 Page SS15



Chubb WS13 Page SS15



Chubb WS6 Page SS16



Chubb WS16 Page SS16



Chubb WS12 Page SS16



Chubb WS14 Page SS16

Security for Sliding Doors



Chubb 8K107 Page SS17



Chubb 8K119 Page SS17



Chubb 8K116 Page SS17



Chubb 8K122 Page SS18

Chubb®

Door Security



Chubb Security for Hinged Doors

		Security Features					Features / Functions					Door Specification		Finish Options				
		Drill Resistant	Saw Resistant	Tamper Resistant	Key Control	Guarantee	Universal/Unique Key	Approx. Angle of Vision	Locking Key	Method Manual	Extended Key Option	Fitting Aids Supplied	Other Features	Door Material	Door Thickness mm	Brass	Chrome	Other
8002	Security Door Bolt			●	E	10	Univ		●	●			T		●		White	
8004	Economy Door Bolt			●	E	10	Univ		●	●			T		●		White	
8006	High Security Door Bolt	●	●	●	E	10	Univ		●	●			T		●		White	
8K117	Door Bolt Upgrade Cylinder				F	10	Uniq		●				T		●		White	
8V001	Door Viewer					10		170°					M,T,P	27 to 57	●	●		
WS8	Door Viewer					10		130°					M,T,P	25 to 57	●	●		
WS9	Door Viewer					10		170°					M,T,P	40 to 95	●	●		
WS13	Door Viewer					10		130°					M,T,P	35 to 57	●	●		
WS6	Door Chain					10			●				T		●	●		
WS16	Door Chain and Bolt					10			●				T		●			
WS12	Security Hinge Bolt			●		10							T				White Brown	
WS14	Security Hinge Bolt			●		10							T			●		

Chubb Security for Sliding Doors

8K107	Sliding Door Lock			●	KA	10	Uniq		●		DB		M			●	
8K119	Sliding Door Indicator Lock			●	F	10	Uniq		●			UI	M			●	White
8K116	Multi Purpose Door Bolt			●	F	10	Uniq		●		DB	OS	M,T			●	Silver
8K122	Anti-Lift Device			●		10							M,P				White

Key: Fittings Supplied: DB = Drill Bit

Other Features: OS = One way Screws UI = Unlocked Indicator



Door Security

Security for Hinged Doors

Chubb 8002 Security Door Bolt

- Mortise fixing with bolt throwing into the frame.
- Lock is invisible from outside of door.



Chubb 8004 Economy Door Bolt

- Mortise fixing with bolt throwing into the door frame.
- Lock is invisible from the outside of door.
- Cost effective plastic body.



Chubb 8006 High Security Door Bolt

- As the 8002 with additional Security.
- Hardened bolt giving added sawing protection.
- Metal sleeve around key mechanism giving added drilling protection.



	8002	8004	8006
Security Features			
Drill Resistant			•
Saw Resistant			•
Tamper Resistant	•	•	•
Key Control	E	E	E
Guarantee	10	10	10
Features & Functions			
Universal/Unique Key	Univ	Univ	Univ
Approx. Angle of Vision			
Locking Method	Key	•	•
	Manual		
Extended Key Option	•	•	•
Fitting Aids Supplied			
Other Features			
Door Specification			
Door Material	T	T	T
Door Thickness (mm)			
Finish Options			
Brass	•	•	•
Chrome			
Other	White	White	White



Door Security

Security for Hinged Doors

Chubb 8K117 Door Bolt upgrade Cylinder

- Provides a security upgrade from a universal key to a unique key mechanism for a mortice door bolt.



Chubb 8V001 Door Viewer

- Adjustable to suit various door thicknesses.

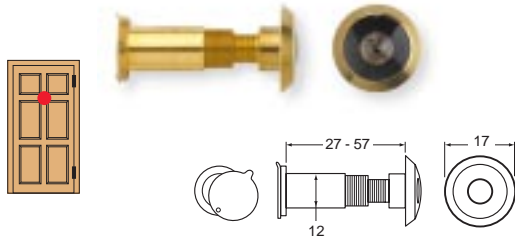

Chubb WS8 Door Viewer

- Adjustable to suit various door thicknesses.

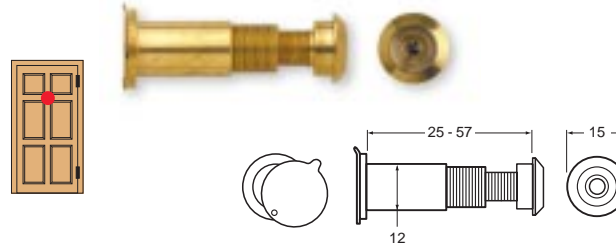

Chubb WS9 Door Viewer

- Adjustable to suit various door thicknesses.

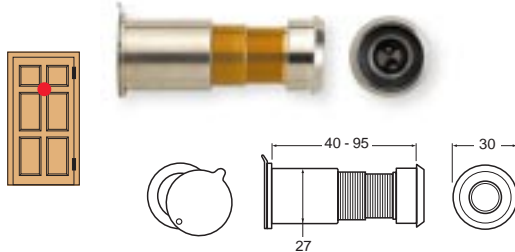

Chubb WS13 Door Viewer

- Adjustable to suit various door thicknesses.

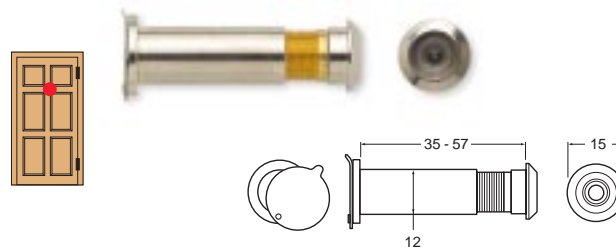

8K117 8V001 WS8 WS9 WS13

Security Features		8K117	8V001	WS8	WS9	WS13
	Drill Resistant					
	Saw Resistant					
	Tamper Resistant					
	Key Control	F				
	Guarantee	10	10	10	10	10
Features & Functions						
Universal/Unique Key		Unique				
Approx. Angle of Vision			170°	130°	170°	130°
Locking Method	Key	●				
	Manual					
Extended Key Option						
Fitting Aids Supplied						
Other Features						
Door Specification						
Door Material		T	M,T,P	M,T,P	M,T,P	M,T,P
Door Thickness (mm)			27 to 57	25 to 57	40 to 95	35 to 57
Finish Options						
Brass		●	●	●	●	●
Chrome			●	●	●	●
Other		White				

Security for Hinged Doors

Chubb WS6 Door Chain

- Simple to install and easy to use.
- Helps to hold the door in the slightly open position, restraining against a force attack.
- Helps you to identify a caller before the door is fully released.

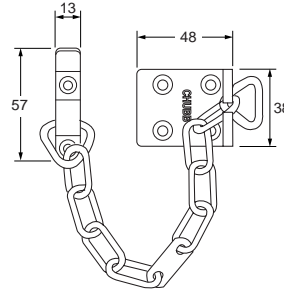
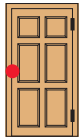

Chubb WS16 Combined Door Chain and Bolt

- Integral steel dead bolt for additional security.
- Heavy Duty Chain helps protect against cropping attack.
- Safe caller identification.
- Angled fixing screws help door restraint against a force attack.

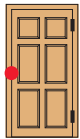

- Handy chain holder supplied as standard.

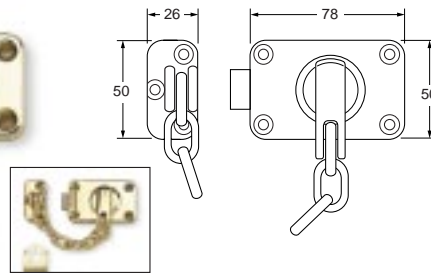

Chubb WS12 Hinge Bolts

- Hinge bolts help keep the door in the frame on the hinged side aiding protection against a force attack.
- Recommended for use in outward opening doors.

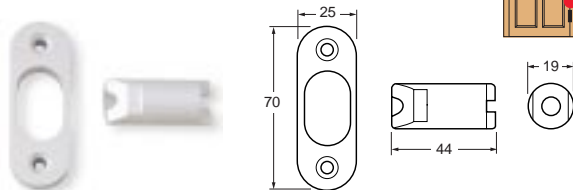

Chubb WS14 Hinge Bolts

- Hinge bolts help keep the door in the frame on the hinged side aiding protection against a force attack.
- Recommended for use in outward opening doors.

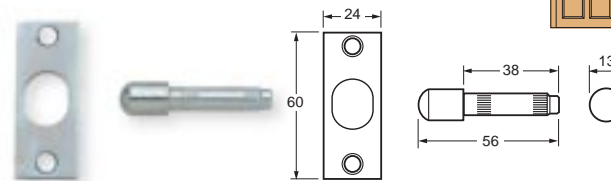

		WS6	WS16	WS12	WS14
Security Features					
	Drill Resistant				
	Saw Resistant				
	Tamper Resistant			•	•
	Key Control				
	Guarantee	10	10	10	10
Features & Functions					
Universal/Unique Key					
Approx. Angle of Vision					
Locking Method	Key				
	Manual	•	•		
Extended Key Option					
Fitting Aids Supplied					
Other Features					
Door Specification					
Door Material		T	T	T	T
Door Thickness (mm)					
Finish Options					
Brass		•	•		
Chrome		•			•
Other		Satin		White Brown	



Security for Sliding Doors

Chubb 8K107 Sliding Door Lock

- Suitable for securing single or double aluminium sliding doors.
- Simple push to lock action.
- A key differing mechanism releases the lock (8K107 has 2000 key variations).
- 8K107 features Tap-tite screws.

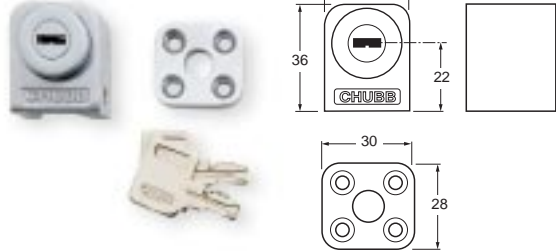
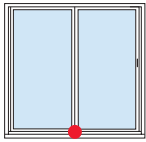

Chubb 8K119 Indicator Lock

- Suitable for securing single or double aluminium sliding doors.
- Simple push to lock action.
- A key differing mechanism releases the lock.

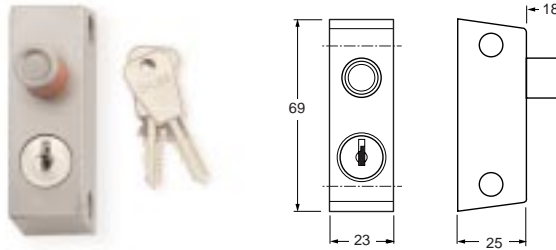
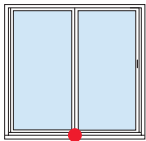

Chubb 8K116 Multi Purpose Door Bolt

- Suitable for securing single or double aluminium sliding doors by means of the steel locking bar.
- Also suitable for hinged doors.
- Simple push to lock action.
- A key differing mechanism releases the bar from the frame.
- Screws suitable for timber or metal doors supplied as standard.

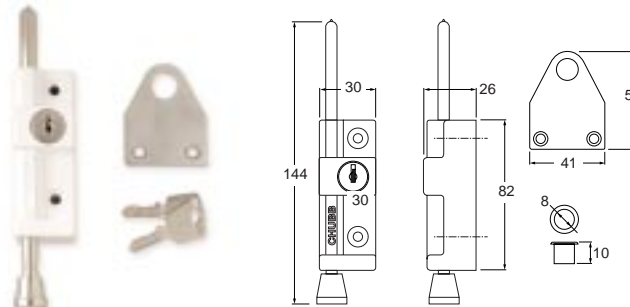
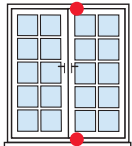

	8K107	8K119	8K116
Security Features			
Drill Resistant			
Saw Resistant			
Tamper Resistant			•
Key Control	KA	F	F
Guarantee	10	10	10
Features & Functions			
Universal/Unique Key	Unique	Unique	Unique
Approx. Angle of Vision			
Locking Method	Key		•
	Manual	•	•
Extended Key Option			
Fitting Aids Supplied	DB		
Other Features			
		UI	OS
Door Specification			
Door Material	M	M	M,T
Door Thickness (mm)			
Finish Options			
Brass			
Chrome	•	•	
Other		White	White Brown



Security for Sliding Doors

Chubb 8K122 Anti-Lift Device

- Helps to prevent sliding patio doors from being lifted out of their frames.
- Easy to install.
- Variable thickness feature to enable fitting in most applications.

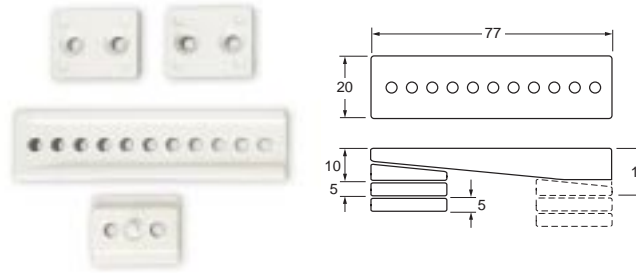
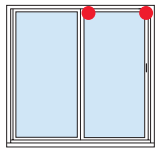

Variations

Chubb Keying Groups

- Many locks in the Chubb range have interchangeable keys and so can be conveniently operated from a single key. Locks offering this option will have either a universal key operation OR a key alike reference which matches it to other products in the same group; eg. the 8K113 is a unique key, in key alike group F, so it could be keyed alike to any other product in group F, like the 8K114.
- For the complete list of Chubb product keying groups, see the chart in the introduction section.

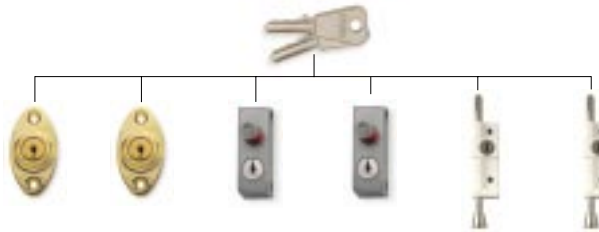

Chubb Extra Length Keys

- For applications where extended key lengths would be useful packs of extra long keys are available, see the price list for details.

		8K122		
Security Features				
	Drill Resistant			
	Saw Resistant			
	Tamper Resistant	•		
	Key Control			
	Guarantee	10		
Features & Functions				
Universal/Unique Key				
Approx. Angle of Vision				
Locking Method	Key			
	Manual			
Extended Key Option				
Fitting Aids Supplied				
Other Features				
Door Specification				
Door Material		M,P		
Door Thickness (mm)				
Finish Options				
Brass				
Chrome				
Other		White		